

[Home](#) > [Products](#) > [PLCs](#) > MicroSmart

Micro PLCs MicroSmart



Overview

IDEC MicroSmart series PLC is the next generation of programmable logic controller. These flexible, adaptable PLCs are as compact as they are powerful, so you can create the system you need without increasing your space requirements or your budget.

MicroSmart CPUs are available with built-in 10, 16, and 24 I/O All-In-One units, and 20 and 40 I/O slim style models.

Each MicroSmart CPU is designed in a compact and rugged housing. Every MicroSmart module meets IDEC strict quality standards and complies with all major international standards; cULus, CE, TUV, and Lloyds.

Each CPU is equipped with a standard power supply circuit, four high-speed counters, analog potentiometer, and password protection.

The Slim type and the 24 I/O All-in-one CPU can be expanded with the many choices of expansion

modules. There are 20 modules available including four analog I/O modules, an AS-interface master communication module, and our most recent addition to the MicroSmart family, the 8-pt AC input module. In addition, 24V DC All-in-one CPUs are now available. Depending upon the CPU, you can create a system with as many as 264 I/Os.

Each MicroSmart module can be enhanced with a memory cartridge for easy maintenance, a real-time clock and calendar cartridge for real time applications, and an RS-485/RS-232 communications adapter. These adapters allow the MicroSmart CPU to data link to the MicroSmart or other IDEC PLCs, connect to operator interfaces, printers, barcode readers, or other RS-232 devices such as modems for remote communication.

MicroSmart PLCs are programmable with WindLDR, IDEC's intuitive ladder logic software. The current WindLDR version 5.03 has improved features such as a split ladder window for easy navigation, improved tag name editor and rung comment search. Download your free demo now or upgrade to WindLDR 5.03 if you have version 4.0 or later.

Key Features

- Available in Slim or All-In-One styles
- CPU units are equipped with 10, 16, 20, 24, or 40 I/Os.
- Maximum of 264 I/Os can be configured on a single MicroSmart CPU
- Your choice of many expansion modules: AC/DC inputs, relay/transistor outputs, RTD/ Thermocouple and Analog I/Os, and AS-interface Master communication module
- Standard RS232 port, optional plug-in RS485/RS232 port for data link or modem communications
- Optional plug-in HMI module for monitoring, memory cartridge, and real-time clock and calendar cartridge
- Built in Modbus-CRC, PID and Ramp functions
- 4 built-in high speed counters, interrupt and catch inputs, and password protection
- Data link for up to 32 MicroSmart or other IDEC PLCs
- cULus, CE, TUV and Lloyds approved
- Approved for Class 1 Div 2 Hazardous Locations
- Easy programming using IDEC exclusive WindLDR software
- New web server module for faster, easier ethernet connectivity

FC4A-C16R2C

[The MicroSmart is available in either Slim type or the All-In-One type with expandability up to 264 I/O.]





Product Specifications

PLC Product Category CPU Unit

Operating Voltage 24V DC

High Speed Counter(s) 20kHz, 5kHz

High Speed Counter Input Type Sink, Source

RS485 Ports 1, Separate Module Required

On Board Communication Port 1 RS-232

Memory Card Slot Yes

On Board Input Type Transistor Sink, Transistor Source

On Board Output Type Relay

I/O Expandable No

Maximum I/O 16

On Board I/O 9/7

Real Time Clock Yes, Separate Module Required

Connector Type Screw Terminal

Notes MicroSmart All-in-One Brick Style PLC. See catalog pages for further information.

I/O Range Requirement 24 or less

Floating Point Math No

Data Processing 16 Bit

Max. Communication Ports 1, 2

MicroSmart Performance

Features:

- Available in 10, 16, 20, 24, and 40 I/O CPUs.
- PID Controls
 - Program up to 14 PID loops
- High Speed I/O
 - Built-in 4 high speed inputs
 - Single or Dual Phase
 - Max. 20KHz frequency
- Built-in 2 High speed outputs (Slim model only)
- Configure up to 264 I/O Points
- Data link up to 32 MicroSmart and Pentra CPUs
- Using RS485 communication module/port, you can create a network of up to 32 CPUs.
- Worldwide Approvals
 - cULus listed, CE marked
 - Class 1 Div. 2 for hazardous locations
 - Lloyds Registered and ABS approved for shipping industry



PLCs

Operator Interfaces

Automation Software

Power Supplies

Sensors

Communication & Networking

MicroSmart CPU Part Numbers

All-in-One

Appearance	Part Number	Power	I/O Points	Input	Output	Expandability	
	FC4A-C10R2C	24V DC	10 (6 in/ 4 out)			N/A	
	FC4A-C10R2	100-240V AC					
	FC4A-C16R2C	24V DC	16 (9 in/ 7 out)	24V DC (Sink/Source)	Relay		
	FC4A-C16R2	100-240V AC					
	FC4A-C24R2C	24V DC	24 (14 in/ 10 out)				88 Maximum I/O (up to 4 expansion modules)
	FC4A-C24R2	100-240V AC					

Specifications

All-in-One

Part Number	AC Power	FC5A-C10R2	FC5A-C16R2	FC5A-C24R2	FC4A-C10R2	FC4A-C16R2	FC4A-C24R2
	DC Power	FC5A-C10R2C	FC5A-C16R2C	FC5A-C24R2C	FC4A-C10R2C	FC4A-C16R2C	FC4A-C24R2C
Rated Voltage	AC power model: 100 to 240V AC, DC power model: 24V DC						
Allowable Voltage Range	AC power model: 85 to 264V AC, DC power model: 20.4 to 28.8V DC (including ripple)						
Rated Power Frequency	AC power model: 50/60 Hz (47 to 63 Hz)						
Maximum Input Current		250mA (85V AC) 160mA (24V DC)	300mA (85V AC) 190mA (24V DC)	450mA (85V AC) ¹ 360mA (24V DC) ²	250mA (85V AC) 160mA (24V DC)	300mA (85V AC) 190mA (24V DC)	450mA (85V AC) ² 360mA (24V DC) ³
Maximum Power Consumption	AC Power	FC5A-C10R2/FC4A-C10R2: 30VA (264V AC) / 20VA (100V AC) ³ FC5A-C16R2/FC4A-C16R2: 31VA (264V AC) / 22VA (100V AC) ³ FC5A-C24R2/FC4A-C24R2: 40VA (264V AC) / 33VA (100V AC) ¹					
	DC Power	FC5A-C10R2C/FC4A-C10R2C: 3.9W (24V DC) ⁴ FC5A-C16R2C/FC4A-C16R2C: 4.6W (24V DC) ⁴ FC5A-C24R2C/FC4A-C24R2C: 8.7W (24V DC) ²					
Allowable Momentary Power Interruption	10ms (rated power voltage)						
Dielectric Strength	Between power and ⊕ or ⊖ terminals: 1500V AC, 1 minute Between I/O and ⊕ or ⊖ terminals: 1500V AC, 1 minute						
Insulation Resistance	Between power and ⊕ or ⊖ terminals: 10 MΩ minimum (500V DC megger) Between I/O and ⊕ or ⊖ terminals: 10 MΩ minimum (500V DC megger)						
Noise Resistance	AC power terminals: 1.5 kV, 50 ns to 1μs DC power terminals: 1.0 kV, 50 ns to 1μs I/O terminals (coupling clamp): 1.5 kV, 50 ns to 1μs						
Inrush Current		35A		40A		35A	40A
Power Supply Wire	UL1015 AWG22, UL1007 AWG18						
Operating Temperature	0 to 55°C						
Storage Temperature	-25 to +70°C (no freezing)						
Relative Humidity	Level RH1 (IEC61131-2), 1 to 95% RH (no condensation)						
Altitude	Operation: 0 to 2,000m, Transport: 0 to 3,000m						
Pollution Degree	2 (IEC60664-1)						
Corrosion Immunity	Free from corrosive gases						
Degree of Protection	IP20 (IEC60529)						
Grounding Wire	UL1007, AWG16						
Vibration Resistance	When mounted on a DIN rail or panel surface: 5 to 9 Hz amplitude 3.5 mm, 9 to 150 Hz acceleration 9.8 m/s ² (1G), 2 hours per axis on each of three mutually perpendicular axes (IEC61131-2)						
Shock Resistance	147 m/s ² (15G), 11ms duration, 3 shocks per axis, on three mutually perpendicular axes (IEC61131)						
Weight		AC: 230g DC: 240g	AC: 250g DC: 260g	AC: 305g DC: 310g	AC: 230g DC: 240g	AC: 250g DC: 260g	AC: 305g DC: 310g

- 1. CPU module (including 250mA sensor power) + 4 I/O modules
- 2. CPU module + 4 I/O modules
- 3. CPU module (including 250mA sensor power)
- 4. CPU module (24V DC)

PLCs

Operator Interfaces

Automation Software

Power Supplies

Sensors

Communication & Networking

All-in-One

Part Number		FC5A-C10R2 FC5A-C10R2C	FC5A-C16R2 FC5A-C16R2C	FC5A-C24R2 FC5A-C24R2C	FC4A-C10R2 FC4A-C10R2C	FC4A-C16R2 FC4A-C16R2C	FC4A-C24R2 FC4A-C24R2C
Control System		Stored program system					
Instruction Words		35 basic					
Program Capacity ¹		13.8 KB (2,300 steps)	27 KB (4,500 steps)	54 KB (9,000 steps)	4.8 KB (800 steps)	15 KB (2,500 steps)	27 KB (4,500 steps)
User Program Storage		EEPROM (10,000 times rewritable)					
Processing Time	Basic Instruction	1.16ms (1,000 steps)			1.65ms (1,000 steps)		
	END Processing ²	0.64ms			0.64ms		
Expandable I/O Module		—		4 modules		—	
I/O Points	Input	6	9	14	Expansion: 64	6	9
	Output	4	7	10		4	7
Internal Relay		2,048 points		256 points		1,024 points	
Shift Register		128 points		64 points		128 points	
Data Register		2,000 points		400 points		1,300 points	
Extra Data Register		—		—		—	
Counter		256 points		32 points		100 points	
Timer (1-sec, 100-ms, 10-ms, 1-ms)		256 points		32 points		100 points	
RAM Backup	Backup Data	Internal relay, shift register, counter, data register					
	Backup Duration	Approx. 30 days (typical) at 25°C after backup battery fully charged					
	Battery	Lithium secondary battery					
	Charging Time	Approx. 15 hours for charging from 0% to 90% of full charge					
	Battery Life	5 years					
	Replaceability	N/A					
Self-diagnostic Function		Power failure, watchdog timer, data link connection, user program EEPROM sum check, timer/counter preset value sum check, user program RAM sum check, keep data, user program syntax, user program writing, CPU module, clock IC, I/O bus initialize, user program execution					
Input Filter		Without filter or 3 to 15ms filter (selectable in increments of 1ms)					
Catch Input/Interrupt Input		Four inputs (I2 through I5) Minimum turn on pulse width: 40µs minimum Minimum turn off pulse width: 150µs minimum					
High-speed Counter	Maximum Counting Frequency and High-speed Counter Points	Total 4 points Single/two-phase selectable: 50KHz (1 point) Single-phase: 5KHz (3 points)			Total 4 points Single/two-phase selectable: 20KHz (1 point) Single-phase: 5KHz (3 points)		
	Counting Range	0 to 65535 (16 bits)					
	Operation Mode	Rotary encoder mode and adding counter mode					
Analog Potentiometer	Number	1 point		2 points		1 point	
	Data Range	0 to 255					
Analog Voltage Input	Number	—					
	Input Voltage Range	—					
	Input Impedance	—					
Pulse Output	Data Range	—					
	Number	—					
Sensor Power Supply (AC Power Only)	Max. Frequency	—					
	Output Voltage Current	24V DC (+10% to -15%), 250mA					
	Overload Detection	N/A					
Isolation		Isolated from the internal circuit					
Port 1		RS232C (maintenance communication, user communication)					
Port 2 Communication Adapter (option) ³		Possible	Possible	Possible	—	Possible	Possible
Clock Cartridge (option)		Possible	Possible	Possible	Possible	Possible	Possible
Memory Cartridge (option)		Possible	Possible	Possible	Possible	Possible	Possible
HMI Module (option)		Possible	Possible	Possible	Possible	Possible	Possible



1. 1 step equals 6 bytes.
 2. Not including expansion I/O service time, clock function processing time, data link processing time, and interrupt processing time.
 3. Maintenance communication, user communication, Modem communication, datalink, Modbus master/slave communication (FC5A only).
- Note: The maximum number of relay outputs that can be turned on simultaneously is 33 including those on the CPU module.

PLCs

Operator Interfaces

Automation Software

Power Supplies

Sensors

Communication & Networking

Communication Port (RS232C Port 1)

Model	Slim CPU	All-in-One CPU
Standards	EIA RS232C	
Maximum Baud Rate	FC5A: 57,600 bps (maintenance communication) FC4A: 19,200 bps (maintenance communication)	
Maintenance Communication	Possible	
User Communication	Possible	
Modem Communication	N/A	
Data Link	N/A	
Cable	Special cable (FC2A-KC4C, FC2A-KP1C, FC4A-KC1C, FC4A-KC2C)	
Isolation between Internal Circuit and Communication Port	Not isolated	

Input Specifications

Part Number	—	FC5A-D16RK1 FC5A-D16RS1	—	FC5A-D32K3 FC5A-D32S3	—	FC5A-C10R2 FC5A-C10R2C	FC5A-C16R2 FC5A-C16R2C	FC5A-C24R2 FC5A-C24R2C
	FC4A-D20K3 FC4A-D20S3	—	FC4A-D20RK1 FC4A-D20RS1	—	FC4A-D40K3 FC4A-D40S3	FC4A-C10R2 FC4A-C10R2C	FC4A-C16R2 FC4A-C16R2C	FC4A-C24R2 FC4A-C24R2C
Input Points	12 (12/1 common)	8 (8/1 common)	12 (12/1 common)	16 (8/1 common)	24 (12/1 common)	6 (6/1 common)	9 (9/1 common)	14 (14/1 common)
Input Voltage	24V DC sink/source input signal							
Input Voltage Range	20.4 to 26.4V DC					20.4 to 28.8V DC		
Input Current	FC5A I0, I1, I3, I4, I6, I7: 4.5mA/point (24V DC) I2, I5, I10 to I17: 7mA/point (24V DC) FC4A I0, I1, I6, I7: 5mA/point (24V DC) I2 to I5, I10 to I27: 7mA/point (24V DC)					FC5A I0 and I1: 6.4mA/point I2 to I7, I10 to I15: 7mA/point (24V DC) FC4A I0 and I1: 11mA I2 to I7, I10 to I15: 7mA/point (24V DC)		
Input Impedance	FC5A I0, I1, I3, I4, I6, I7: 4.9kΩ I2 to I5, I10 to I17: 3.4kΩ FC4A I0, I1, I6, I7: 5.7kΩ I2 to I5, I10 to I17: 3.4kΩ					FC5A I0 and I1: 3.7kΩ I2 to I7, I10 to I15: 3.4kΩ FC4A I0 and I1: 2.1kΩ I2 to I7, I10 to I15: 3.4kΩ		
Turn ON Time	FC5A I0, I1, I3, I4, I6, I7: 5μs + filter value I2 and I5: 35μs + filter value I10 to I17: 40μs + filter value FC4A I0, I1, I6, I7: 35μs + filter value I2 to I5: 35μs + filter value I10 to I27: 40μs + filter value					FC5A I0 and I1: 2μs + filter value I2 to I7: 35μs + filter value I6, I7, I10 to I15: 40μs + filter value FC4A I0 and I1: 35μs + filter value I2 to I5: 35μs + filter value I6, I7, I10 to I15: 40μs + filter value		
Turn OFF Time	FC5A I0, I1, I3, I4, I6, I7: 5μs + filter value I2 and I5: 150μs + filter value I10 to I17: 150μs + filter value FC4A I0, I1, I6, I7: 45μs + filter value I2 to I5: 150μs + filter value I10 to I27: 150μs + filter value					FC5A I0 and I1: 16μs + filter value I2 to I7: 150μs + filter value I6, I7, I10 to I15: 150μs + filter value FC4A I0 and I1: 45μs + filter value I2 to I5: 150μs + filter value I6, I7, I10 to I15: 150μs + filter value		
Connector	On Mother Board	FL26A2MA (Oki Electric Cable)	MC1.5/18-G-3.81BK (Phoenix Contact)	FL26A2MA (Oki Electric Cable)	—			
	Insertion Durability	100 times minimum					—	
Isolation	Between input terminals: Photocoupler isolated Internal circuit: Not isolated							
Input	Type 1 (IEC61131-2)							
External Load for I/O Interconnection	Not needed							
Single Determination Method	Static							
Effect of Improper Input Connection	Both sinking and sourcing input signals can be connected. If any input exceeding the rated value is applied, permanent damage may be caused.							
Cable Length	3 m in compliance with electromagnetic immunity							

Transistor Sink and Source Output

Part Number	—	FC5A-D16RK1 FC5A-D16RS1	FC5A-D32K3 FC5A-D32S3
	FC4A-D20RK1 FC4A-D20RS1	—	FC4A-D40K3 FC4A-D40S3
Output Points	2 (2/1 common)	2 (2/1 common)	16 (8/1 common)
Output	Transistor Sink	FC5A-D16K1/D32K3 FC4A-D20K3/D20RK1/D40K3	
	Transistor Source	FC5A-D16RS1/D32S3 FC4A-D20S3/D20RS1/D40S3	
Load Voltage	24V DC		
Operating Load Voltage Range	20.4 to 28.8V DC		
Load Current	0.3A per output point		
Maximum Load Current	1A per common		
Voltage Drop (ON Voltage)	1V maximum (voltage between COM and output terminals when output is on)		
Inrush Current	1A		
Leakage Current	0.1mA maximum		
Clamping Voltage	39V±1V		
Maximum Lamp Load	8W		
Inductive Load	L/R = 10ms (28.8V DC, 1 Hz)		
External Current Draw	Sink output: 100mA maximum, 24V DC (power voltage at the +V terminal) Source output: 100mA maximum, 24V DC (power voltage at the -V terminal)		
Isolation	Between output terminal and internal circuit: Photocoupler isolated Between output terminals: Not isolated		
Connector on Mother Board	FL26A2MA (Oki Electric Cable)	MC1.5/16-G-3.81BK (Phoenix Contact)	FL26A2MA (Oki Electric Cable)
Connector Insertion/Removal Durability	100 times minimum		
Output Delay	Turn ON Time	FC5A Q0 to Q2: 5µs max. Q3 to Q7, Q10 to Q17: 300µs max. FC4A Q0, Q1: 5µs max. Q2 to Q7, Q10 to Q17: 300µs max.	
	Turn OFF Time	FC5A Q0 to Q2: 5µs max. Q3 to Q7, Q10 to Q17: 300µs max. FC4A Q0, Q1: 5µs max. Q2 to Q7, Q10 to Q17: 300µs max.	

Relay Output

Part Number	FC5A-C10R2 FC5A-C10R2C	FC5A-C16R2 FC5A-C16R2C	FC5A-C24R2 FC5A-C24R2C	FC5A-D16RK1 FC5A-D16RS1	
	FC4A-C10R2 FC4A-C10R2C	FC4A-C16R2 FC4A-C16R2C	FC4A-C24R2 FC4A-C24R2C	FC4A-D20RK1 FC4A-D20RS1	
No. of Outputs	4	7	10	8	
Output Points per Common Line	COM0	3	4	4	2 (Transistor output)
	COM1	1	2	4	3
	COM2	—	1	1	2
	COM3	—	—	1	1
Output	1 NO form A				
Maximum Load Current	2A per point 8A per common line				
Minimum Switching Load	0.1mA/0.1V DC (reference value)				
Initial Contact Resistance	30 mΩ maximum				
Electrical Life	100,000 operations minimum (rated load 1,800 operations/hour)				
Mechanical Life	20,000,000 operations minimum (no load 18,000 operations/hour)				
Rated Load	240V AC/2A (resistive load, inductive load cos φ = 0.4) 30V DC/2A (resistive load, inductive load L/R = 7ms)				
Dielectric Strength	Between output and terminals: 1,500V AC, 1 minute Between output terminal and internal circuit: 1,500V AC, 1 minute Between output terminals (COMs): 1,500V AC, 1 minute				
Connector on Mother Board	—			*	
Connector Insertion/Removal Durability	—			100 times minimum	



*MC1.5/16-G-3.81BK (Phoenix Contact)

PLCs

Operator Interfaces

Automation Software

Power Supplies

Sensors

Communication & Networking

Dimensions (mm)

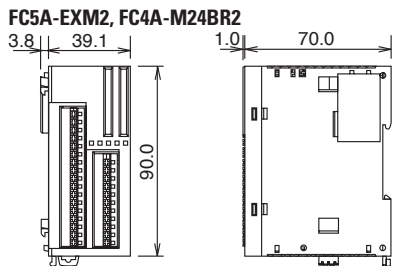
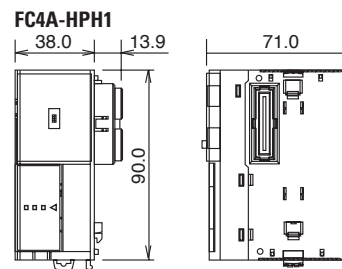
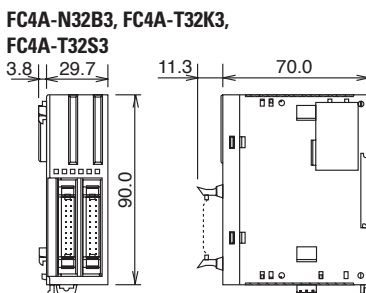
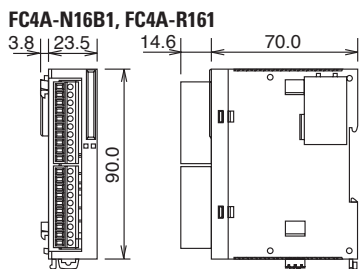
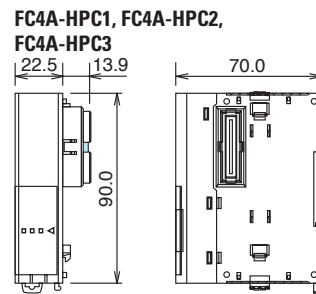
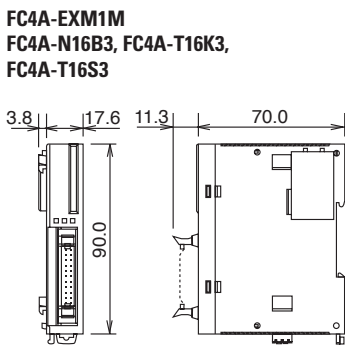
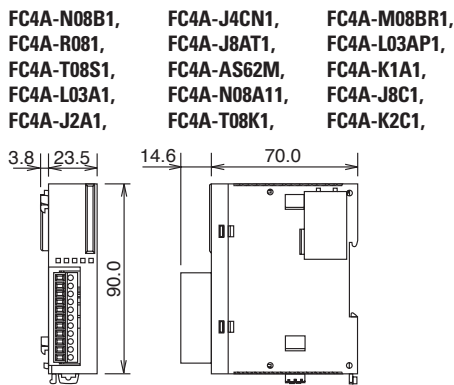
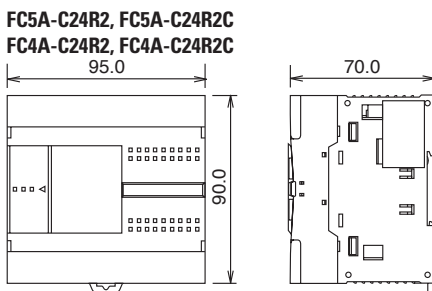
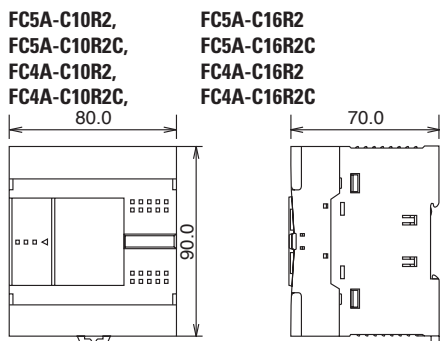
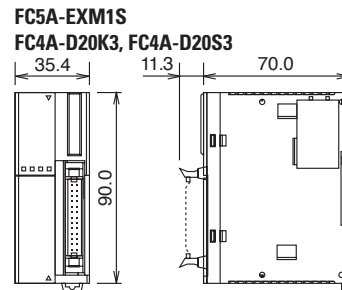
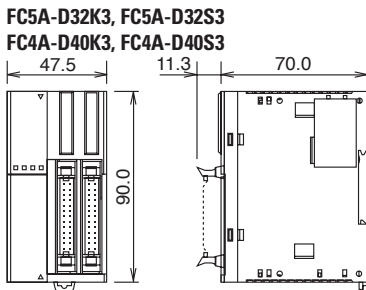
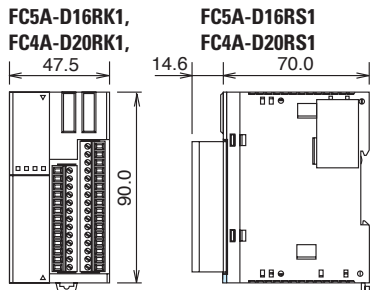

Example

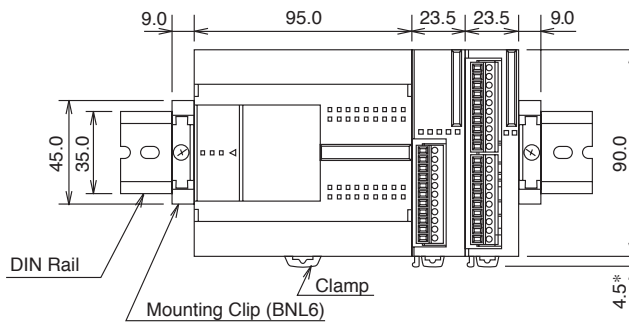

The figure illustrates a system setup consisting of the all-in-one 24-I/O CPU module, an 8-point relay output module, and a 16-point DC input module mounted on a 35-mm-wide-DIN rail using BNL6 mounting clips.

Mounting Hole Layout (mm)

FC5A-C10R2, FC5A-C16R2
 FC5A-C10R2C, FC5A-C16R2C
 FC4A-C10R2, FC4A-C16R2
 FC4A-C10R2C, FC4A-C16R2C

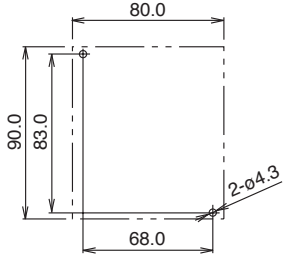

FC4A-N08A11, FC4A-R081
 FC4A-R161, FC4A-T08K1
 FC4A-T08S1, FC4A-M08BR1
 FC4A-L03A1, FC4A-L03AP1
 FC4A-J2A1, FC4A-K1A1
 FC4A-J4CN1, FC4A-T8C1
 FC4A-J8AT1, FC4A-K2C1

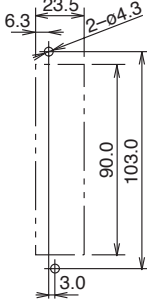

FC5A-EXM2
 FC4A-M24BR2

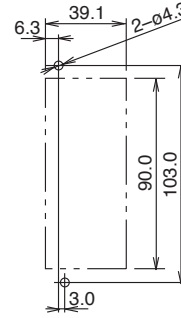

FC5A-EXM1S, FC4A-D20K3
 FC4A-D20S3

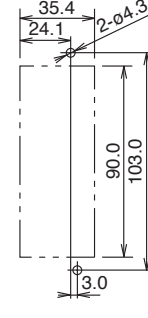

FC5A-C24R2, FC4A-C24R2C
 FC4A-C24R2, FC4A-C24R2C

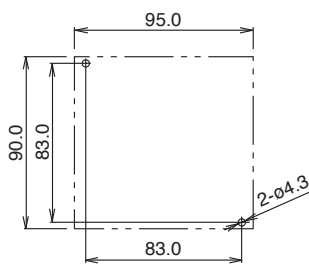

FC5A-EXM1M
 FC4A-N16B3, FC4A-T16K3,
 FC4A-T16S3

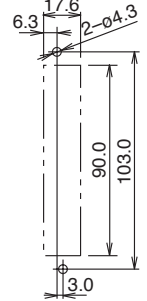

FC4A-HPC1 FC4A-HPC2
 FC4A-HPC3

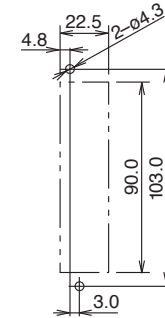

FC4A-N32B3, FC4A-T32K3,
 FC4A-T32S3

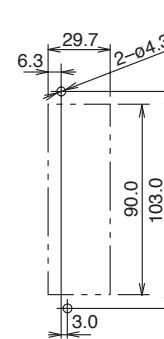

FC5A-D16RK1
 FC5A-D16RS1
 FC5A-D32K3
 FC5A-D32S3
 FC4A-D20RK1
 FC4A-D20RS1
 FC4A-D40K3
 FC4A-D40S3

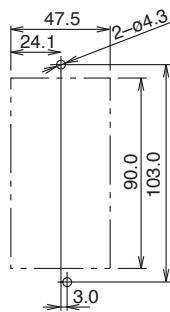

FC4A-HPH1

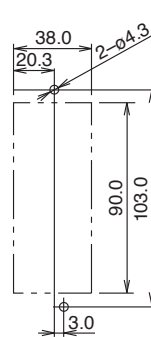

FC4A-HPH1

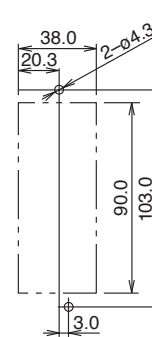

Examples

Mounting hole layout for FC5A-C24R2 or FC4A-C24R2 and four 23.5mm-wide I/O modules

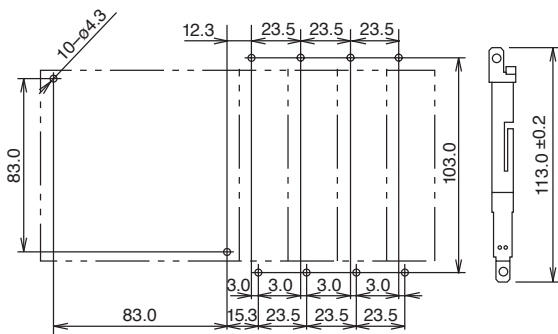

Mounting hole layout from left, FC4A-HPH1, FC4A-D20K3, FC4A-N16B3, FC4A-N32B3, and FC4A-M24BR2 modules

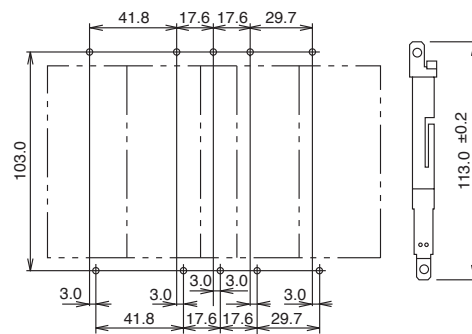

Web Server

General Specifications

Rated Power Voltage	24V DC
Allowable Voltage Range	20.4 to 26.4V DC
Current Draw	70 mA
Allowable Momentary Power Interruption	10 ms maximum
Dielectric Strength	500V AC, 1 minute
Insulation Resistance	10 MΩ minimum (500V DC megger)
Noise Resistance	DC power terminal: 1.0 kV, 50 ns to 1 μs Ethernet cable: 0.5 kV, 50 ns to 1 μs (coupling clamp)
Inrush Current	4A maximum
Operating Temperature	0 to 55°C
Storage Temperature	-40 to +70°C (no freezing)
Relative Humidity	10 to 95% (no condensation)
Pollution Degree	2 (IEC 60664-1)
Corrosion Immunity	Free from corrosive gases
Degree of Protection	IP20 (IEC60529)
Vibration Resistance	When mounted on a DIN rail: 5 to 9 Hz amplitude 3.5 mm 9 to 150 Hz acceleration 9.8 m/s ² (1G) 2 hours in each of 3 axes
Shock Resistance	147 m/s ² (15G), 11 ms duration 3 shocks each in 3 axes
Weight (approx.)	150g

Interface Specifications

Communication	RS232C <=> Ethernet conversion function
Ethernet Specifications	Electrical characteristics: Complies with IEEE802.3 Transmission speed: 10BASE-T/100BASE-TX (Not CE compliant) Communication protocol: IP/ICMP/ARP Ethernet protocol: TCP/SMTP/HTTP/Telnet No. of TCP connections: 1
Serial Interface Specifications	Electrical characteristics: EIA RS232C Transmission speed: 9600 to 115200 bps Synchronization: Asynchronous Communication protocol: Full duplex Transmission control: RTS/CTS, XON/OFF, None
Connection Method	Ethernet interface: RJ45 Serial interface: Mini DIN 8-pin connector Cable Part No.: FC4A-KC3C
Major Functions	Remote maintenance: Uploading, downloading and monitoring using WindLDR via Ethernet Web server: Configure the web server unit using Internet Explorer etc. Reading and writing PLC operands using Java applet. Web file area: 512 KB Compliant browser: Internet Explorer 6.0 or higher, Netscape Navigator 7.2 Ethernet user communication: User communication using Ethernet Message transmission: Registered outgoing message 32 message types, 63 characters maximum per message, 2 email addresses, 64 address characters maximum
Optional	Utility CD: Configuration file, PLC operand monitor sample programs, sample program configuration instructions, instruction manual (English/German/Spanish/Japanese/Chinese)

Connectable Devices

Programmable Controllers

IDEC FC5A MicroSmart
IDEC FC4A MicroSmart
IDEC FC3A OpenNet Controller

Operator Interface

(RS232C communication with PLC through Ethernet)
IDEC HG2F

Dimensions

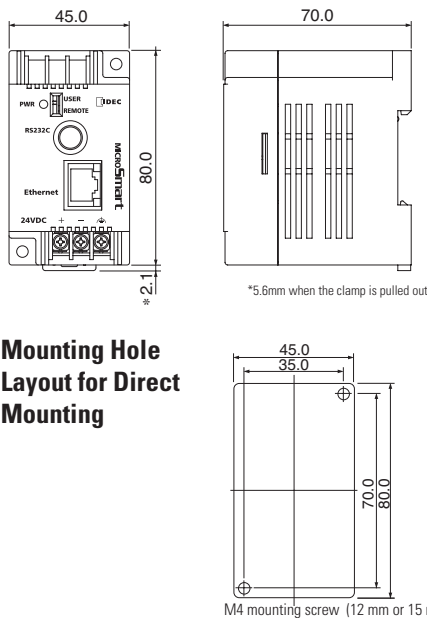

Web Server Cable (FC4A-KC3C, Cable Length: 100 mm)

Cable Dimensions

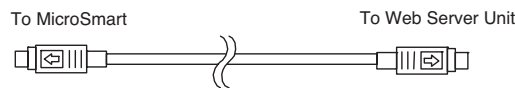

Connector Pinout

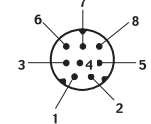

Cable Connection Diagram

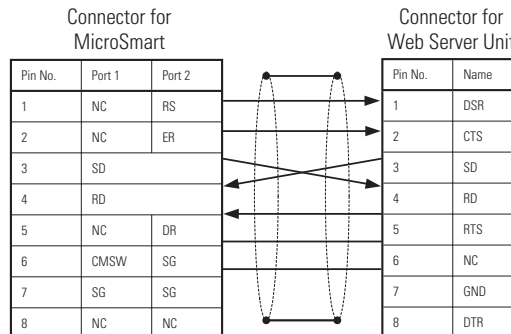

Ethernet is a registered trademark of Xerox Corporation.